

# FAC

## User Guide



**SwellPro**

Visit [www.swellpro.com](http://www.swellpro.com) for the latest version of this manual and firmware updates for your drone and accessories.

V1.0 – June 2021

## Thank you

The FAC camera is a fixed angle waterproof full HD camera designed for SplashDrone 4 to maintain the vision in flight while also features photo shooting & full HD video recording capability. The FAC camera is extremely compact and lightweight which won't affect the flight time during the operation.

## Using this manual

This document is designed to be printed or viewed on a computer or mobile device.

## Tutorial videos

To watch tutorial videos or download the firmware, please visit SwellPro website [www.swellpro.com](http://www.swellpro.com)

# Contents

Thank you.....	2
Using this manual .....	2
Tutorial videos.....	2
CONTENTS.....	3
PRECAUTION .....	4
INSTALLATION .....	4
Install the Camera .....	4
Install SD Card .....	5
After Use Casing .....	5
CONTROL .....	6
Camera Status Indicator .....	6
Camera Control .....	7
APP INTERFACE .....	7
SPECIFICATION .....	10
Version Information .....	10

## Precaution

- The FAC camera is a piece of precision electronics with corrosion-resistant materials which allow for use in harsh marine environments. As with any marine equipment, trouble-free and lasting operations depend on proper attention and maintenance of the equipment.
- When taking off or landing, slowly proceed to avoid damage to the camera which can cause by the huge impact when contacting the surface at high speeds. Drop or crash directly into the water from above will result in significant damage to the drone and the camera.
- After using in seawater, soak and rinse thoroughly with clean fresh water before the seawater dries out.
- If seawater or other sediments form on the camera, soak thoroughly with fresh water and clean all sediments on the camera before use. For more information, check the drone's "Maintenance manual".

## Installation

### Install the Camera

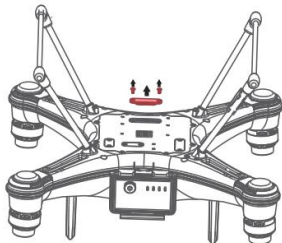

1. Unscrew and take off the camera port cover plate using a hex screwdriver. (equipped with SplashDrone 4)

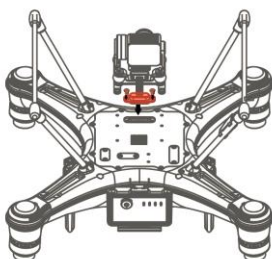

2. Plug the camera connector into the drone's gimbal port and screw it in place with a screwdriver.

**⚠ Make sure the rubber ring is attached to the camera connector before you screw the connector.**

**⚠ Make sure the connector plate is clean and free of any sand or other particles.**

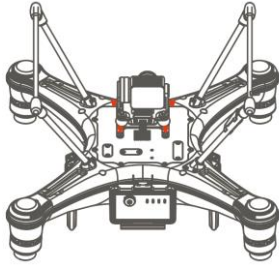

3. Align the holes on the base of the gimbal to the bottom of the drone, screw in to mount the gimbal. Make sure the camera is pointing to the front of the drone.

## Install SD Card

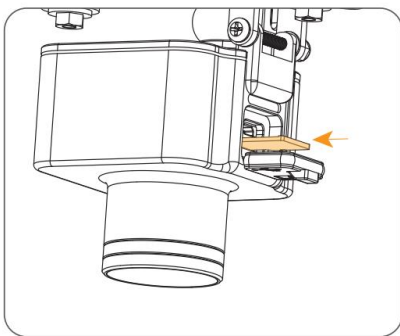

1. Open the soft rubber seal on the top of the camera, insert the Micro SD card in the correct direction, press the Micro SD card, the "click" sound indicates that the installation is in place.
2. After installing the Micro SD card, plug the rubber seal back.

**⚠ Make sure the rubber seal is tightly plugged in to ensure waterproofing.**

- The FAC camera supports Micro SD cards with a maximum capacity of 128GB. Since the camera requires fast reading and writing of high-stream video data, please use Micro SD cards with Class 10 or UHS-1 or above to ensure proper functioning.
- Do not insert or unplug the Micro SD card during aircraft shooting, as data files may be damaged or lost.
- Once you are done recording, stop recording and save the file. If you turn off the power directly before saving the files, the recording file might be damage.

## After Use Casing

After using the camera, you can choose not to take off the gimbal camera and put it directly into the case with the drone. Follow the following steps to make sure the gimbal camera is properly secure after casing.

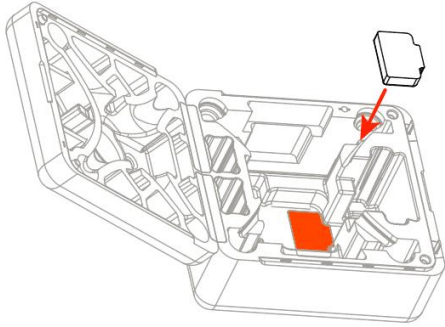

1. Remove the double-side-glued pad from the gimbal box and paste the pad into the drone's case as showing to the left.

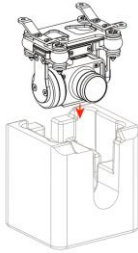





2. After cleaning and drying the gimbal camera and the aircraft, secure the gimbal camera with the fixing case, then put the aircraft and other parts into the case. The case is secure and ready to be carried or transported.

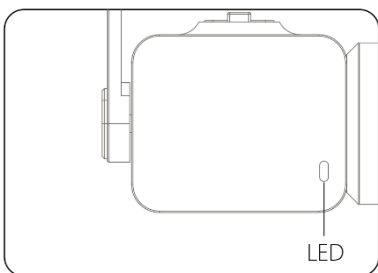

## Control

### Camera Status Indicator

There is a camera status indicator on the back of the camera to indicate the camera's working status. It flashes green or red.



LED		
	Solid Green	Ready to shoot
	Flashing Green	No SD card
	Flashing Red Once	Taking photo
	Flashing Red	Video recording

 Solid     
  Flashing

## Camera Control

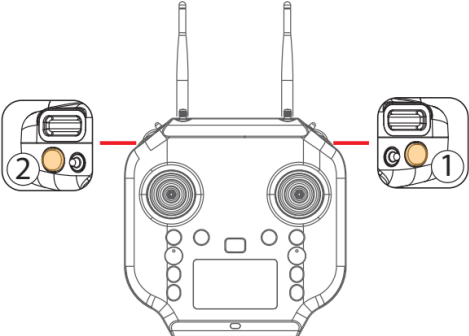
Remote controller	Description
	<p>Photo①: press once to take a picture.</p> <p>Video②: press once to start recording, press again to stop recording, and save files.</p>

## APP Interface

To get into APP's camera interface: Power on the remote controller, then the aircraft. Connect the phone to the remote controller's Wi-Fi hotspot. Then click "Login device".

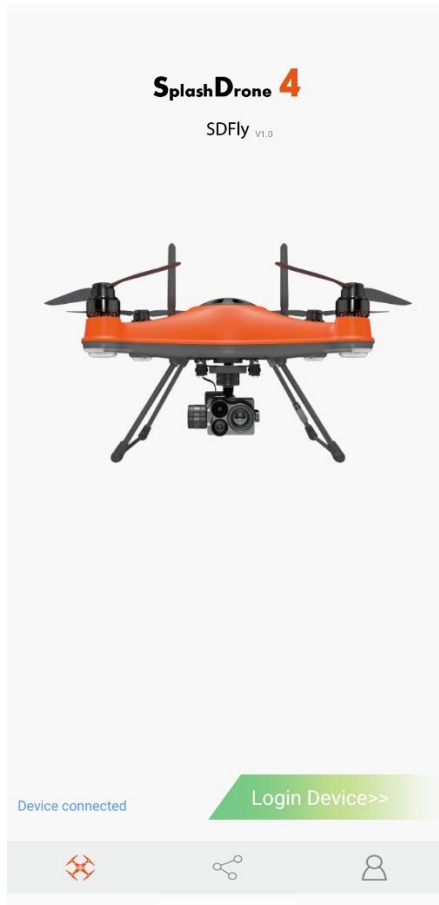

Login device

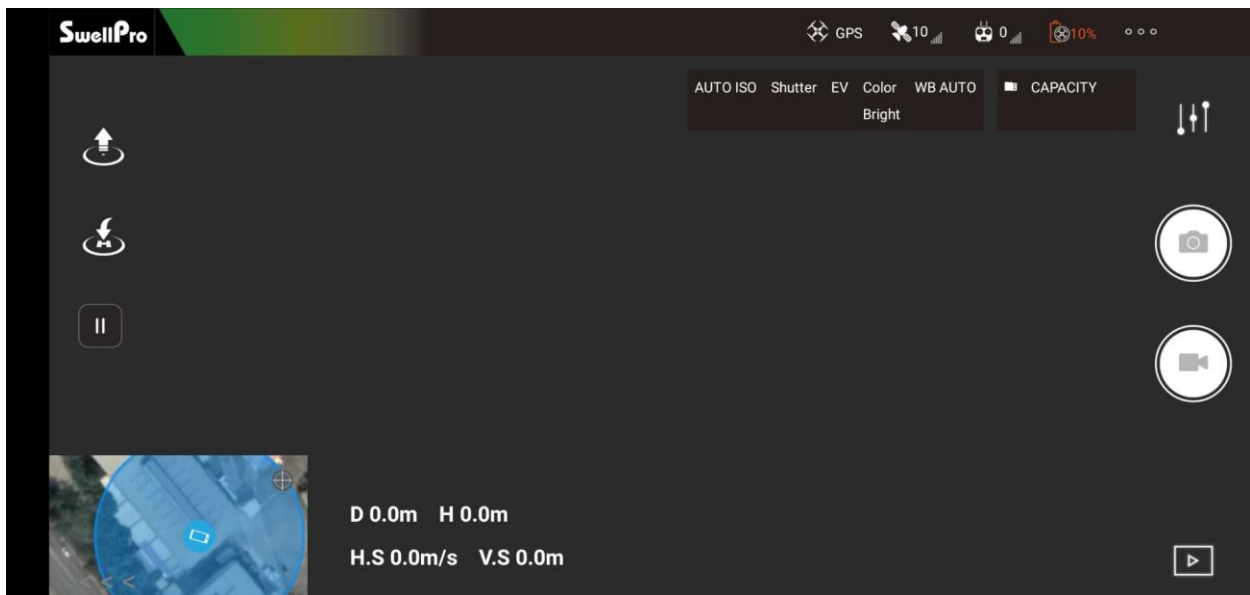

Camera Interface



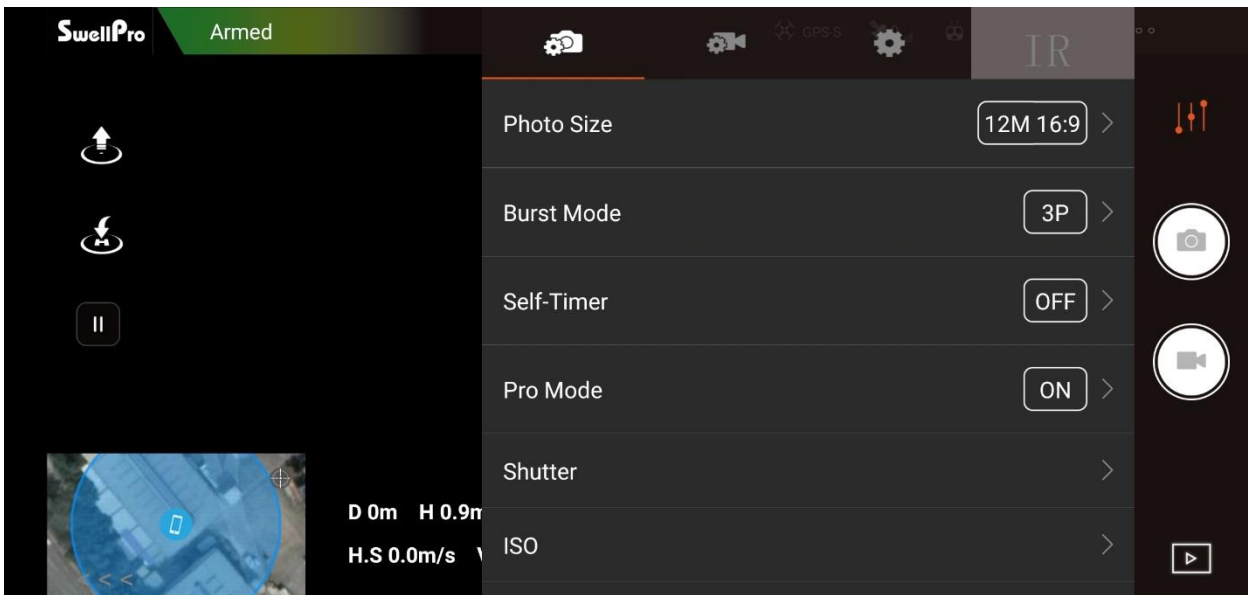
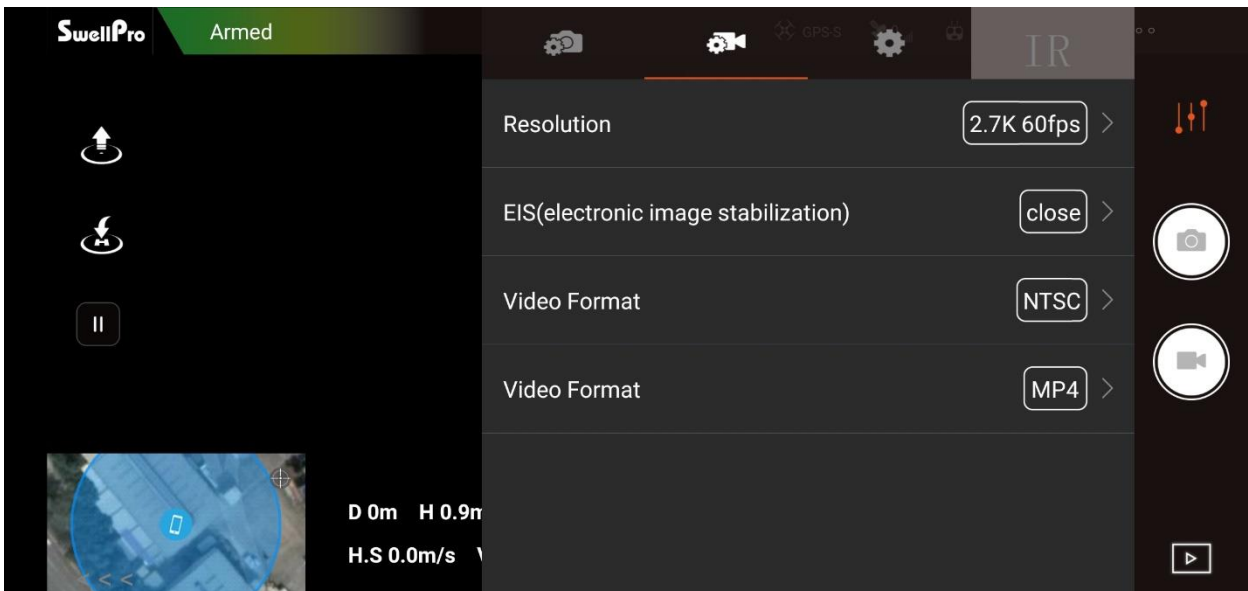
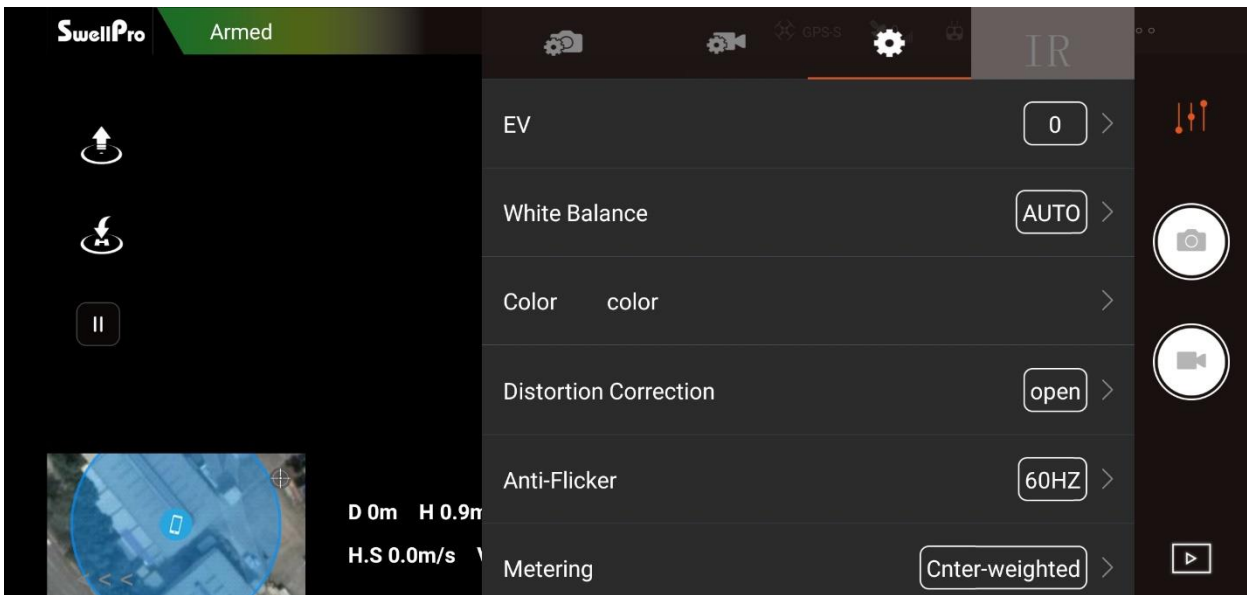

Photo Setting Interface



Video Setting Interface



Camera Setting Interface

## Specification

<b>FAC</b>	
<b>Waterproof Rating:</b>	IP67
<b>Weight:</b>	Approx. 85g
<b>Size:</b>	45*44*40mm
<b>Sensors:</b>	1/2.7" 2M CMOS
<b>Lens:</b>	F2.2mm; f/5.06; FOV: 130°
<b>Burst mode:</b>	3/5/10 pcs
<b>Video resolution:</b>	FHD: 1920*1080 30/60p   HD: 1280*720 120/60p
<b>Max data stream:</b>	30 Mbps
<b>Photo format:</b>	JPEG
<b>Video format:</b>	MP4, MOV
<b>Memory card:</b>	Micro SD card: supports up to 128GB of capacity, write speeds $\geq 30$ MB/s, recommend using Class 10 or above, or with UHS-1 rating.
<b>Working temperature:</b>	-10°C - 40°C

## Version Information

SwellPro products are constantly improving, so as the product user guides. It is recommended to visit [www.swellpro.com](http://www.swellpro.com) to check and download the latest user guide.

Version

1.0 FAC User Guide First Edition